

BOOT1	BOOT0	MODE
0	0	SPI-NOR
0	1	SPI-NAND
1	0	eMMC
1	1	SD-Card

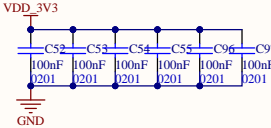

Title		
Size	Number	Revision
A3		
Date:	5/16/2024	Sheet of
File:	D:\2024-1-12_嘉楠K230_0.K230.SchDoc	Drawn By:

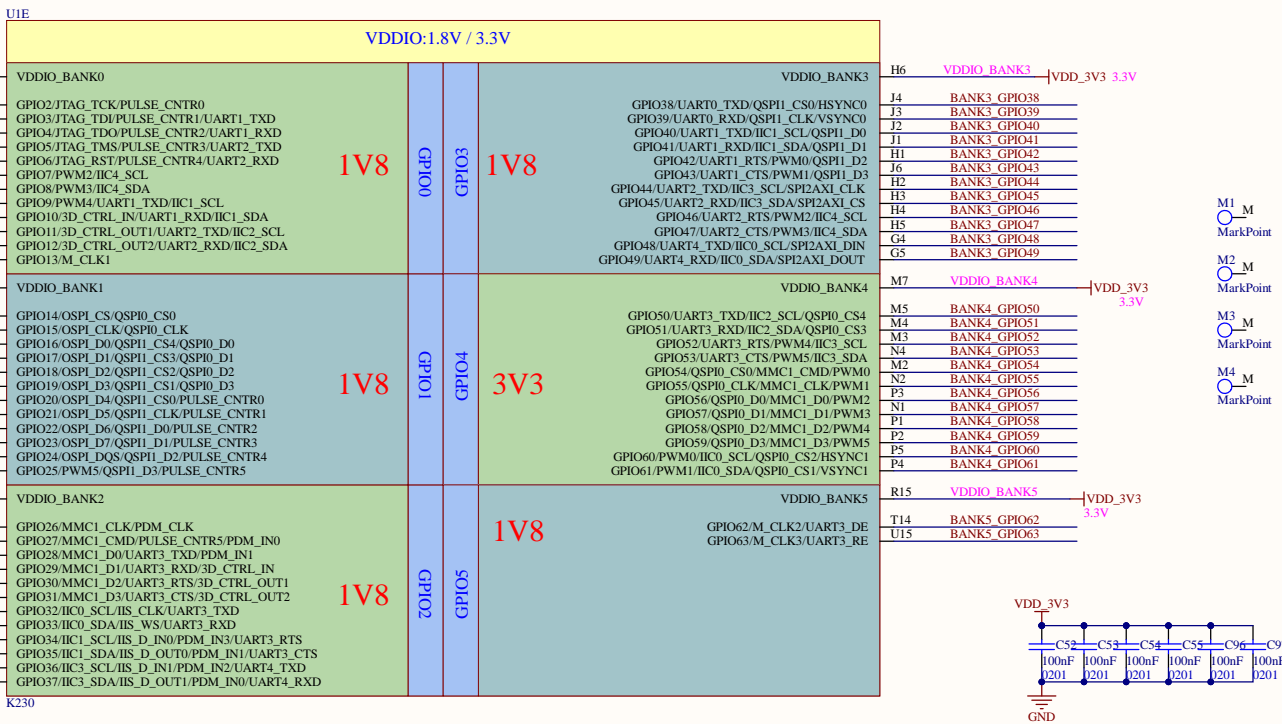
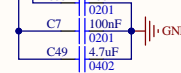
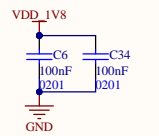
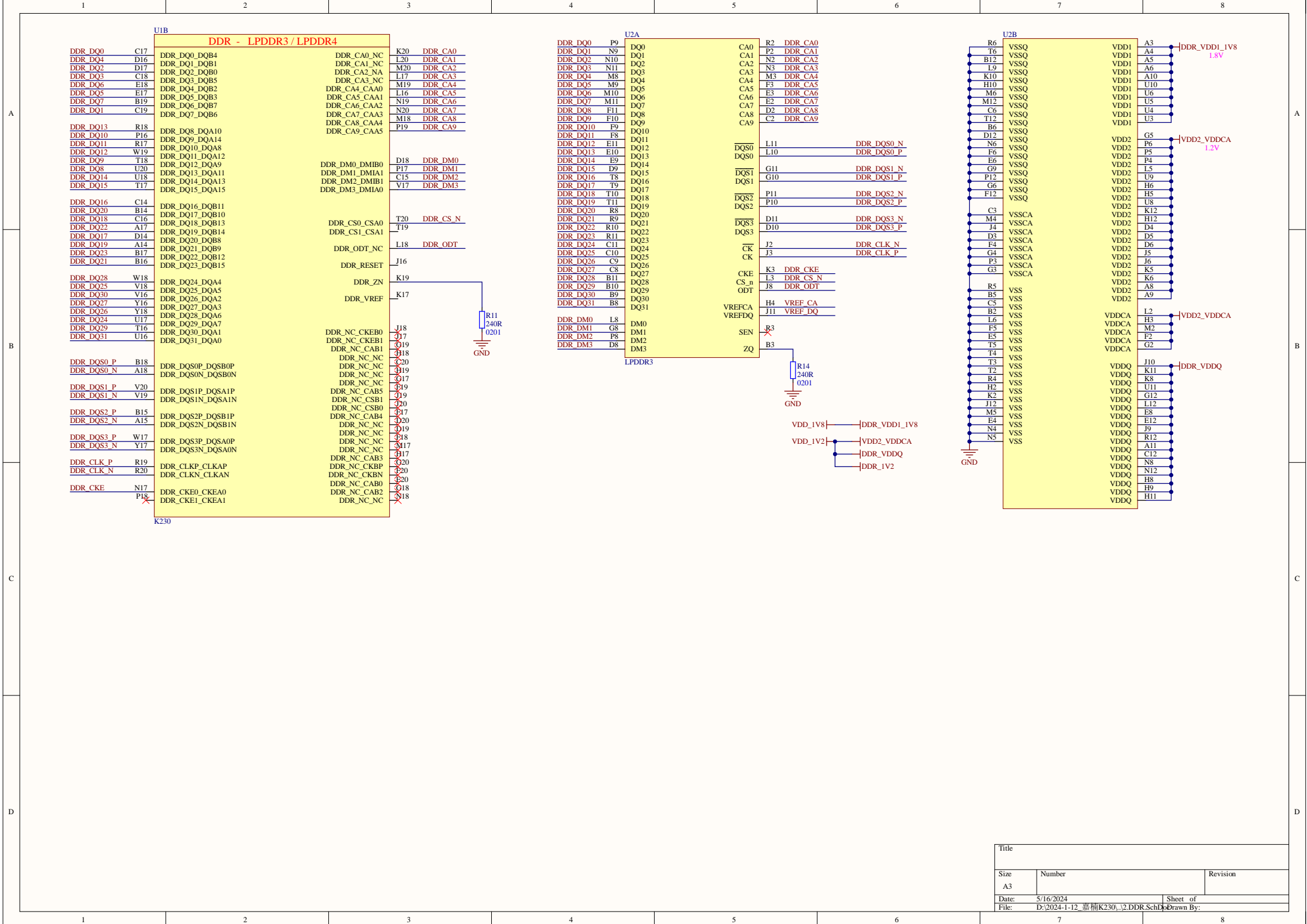

MIPI-K230

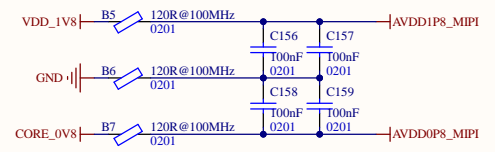
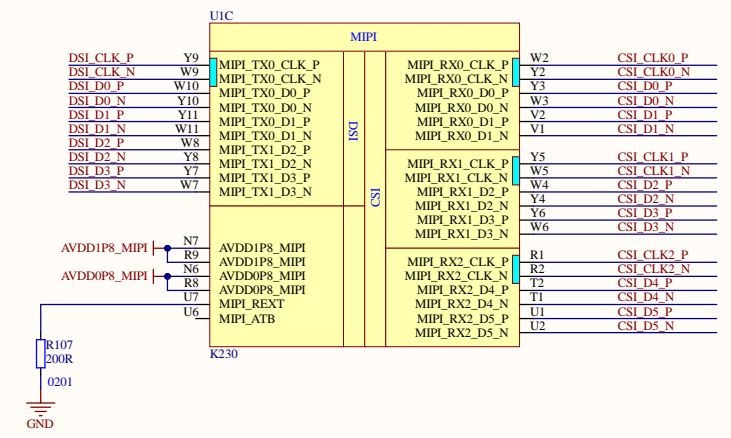
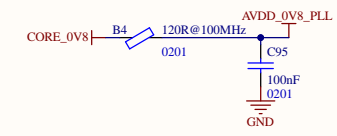
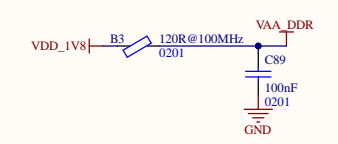

Title		
Size	Number	Revision
A3		
Date:	5/16/2024	Sheet of
File:	D:\2024-1-12_嘉楠K230_1.K230_Power	11/11

POWER

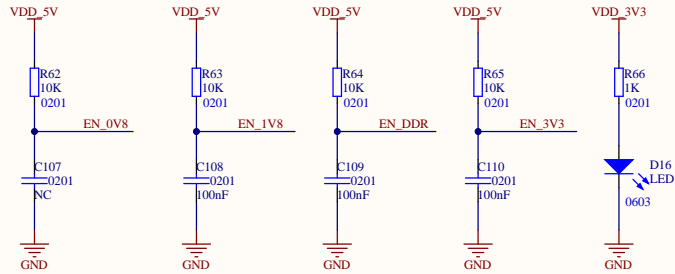
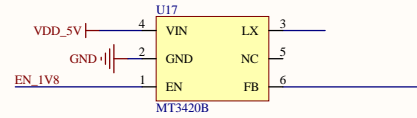
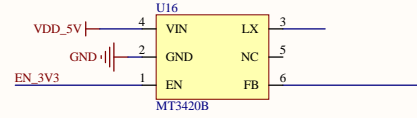
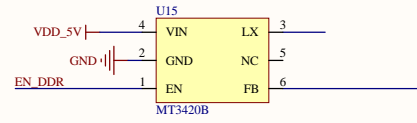
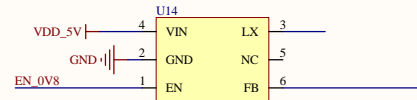
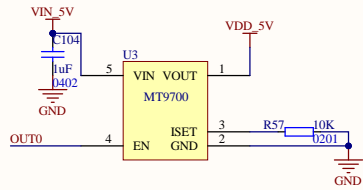
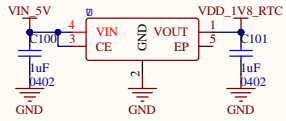

Title		
Size	Number	Revision
A3		
Date:	5/16/2024	Sheet of
File:	D:\2024-1-12_嘉楠K230\14.Power.Sch	Drawn By:

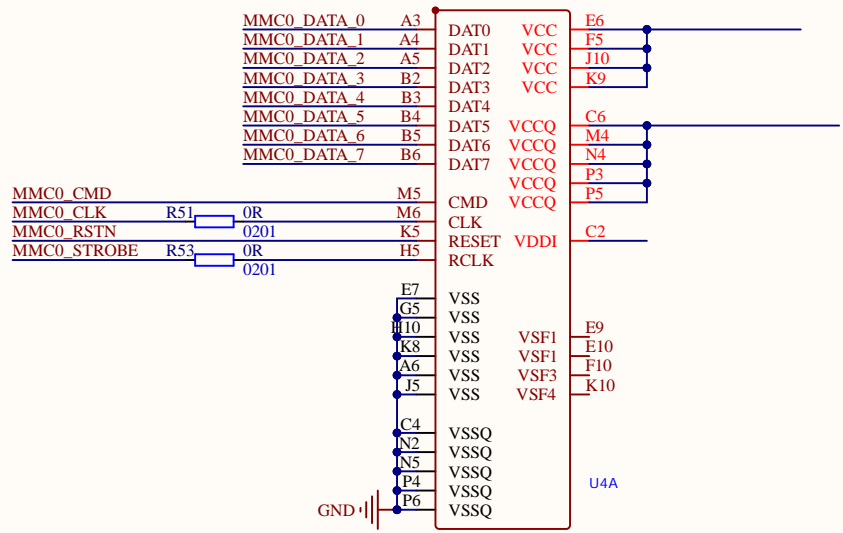

Title		
Size	Number	Revision
A4		
Date:	5/16/2024	Sheet of
File:	D:\2024-1-12_嘉楠K230\13.EMMC.Sch Drawn By:	

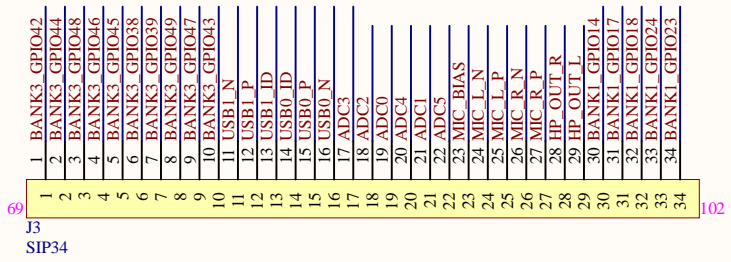
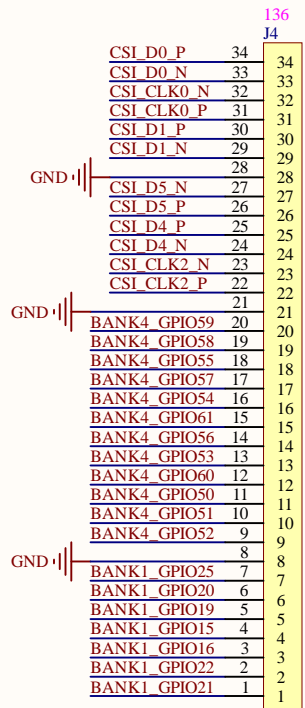
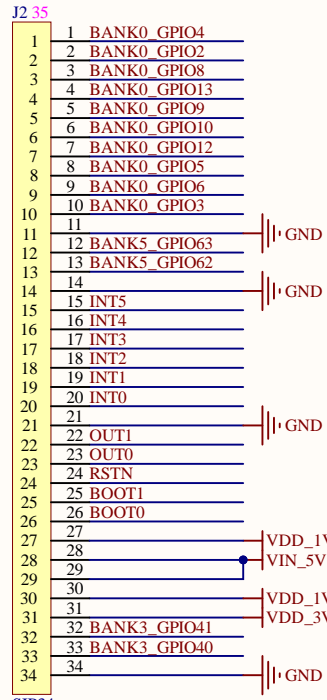
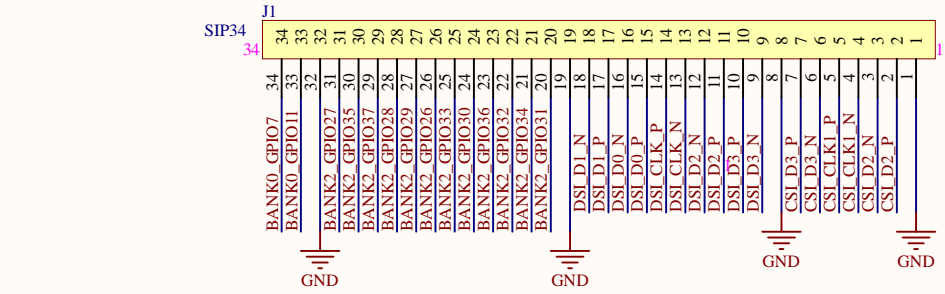

Title		
Size A4	Number	Revision
Date:	5/16/2024	Sheet of
File:	D:\2024-1-12_嘉楠K230\5.IO.SchDoc	Drawn By: